

Interim report presentation January-March 2024

A landscape photograph showing a wind turbine in the distance, silhouetted against a bright, hazy sky at sunrise or sunset. The foreground is a dense forest of evergreen trees. The entire image is framed by a teal border.

Henrik Sjölund, CEO

Anders Jernhall, CFO

April 26th, 2024

Forest

1.3 million ha total land area

1.0 million ha productive forest land



Lack of wood pushing up prices to record levels

Despite slow end markets

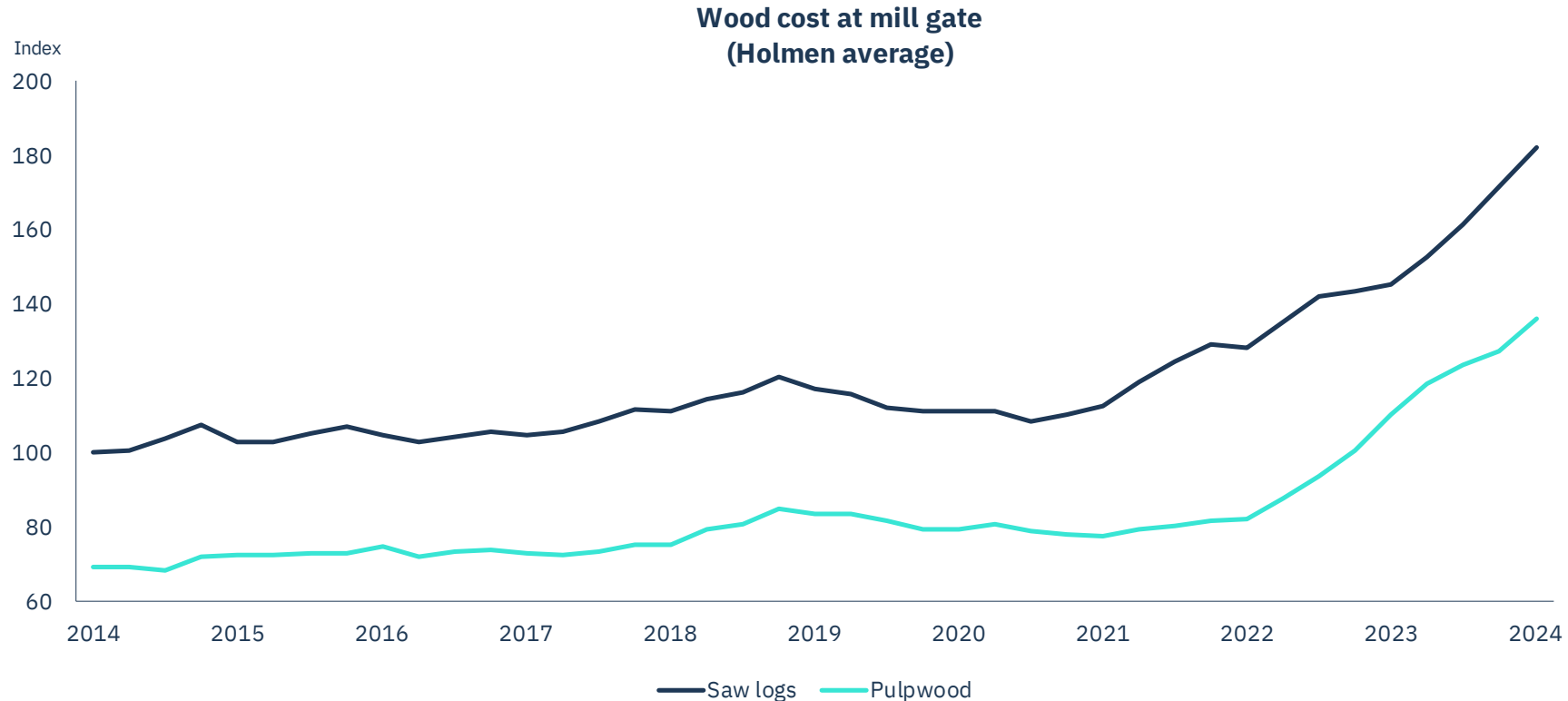

Price increases translating into higher profits

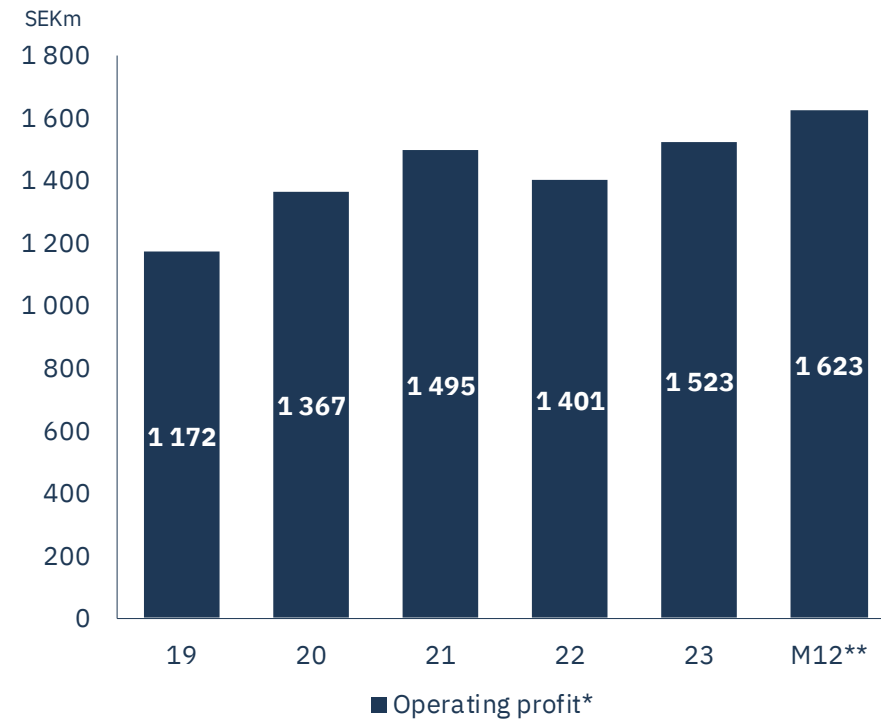
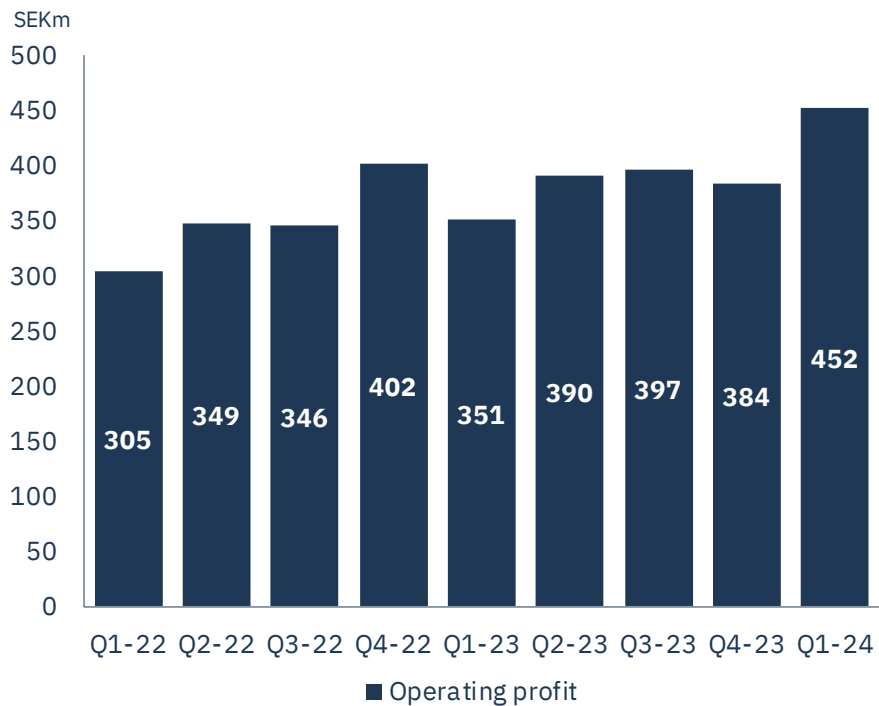

H

Renewable Energy

1.8 TWh per year



Weather & low production kept Nordic power prices high in Q1

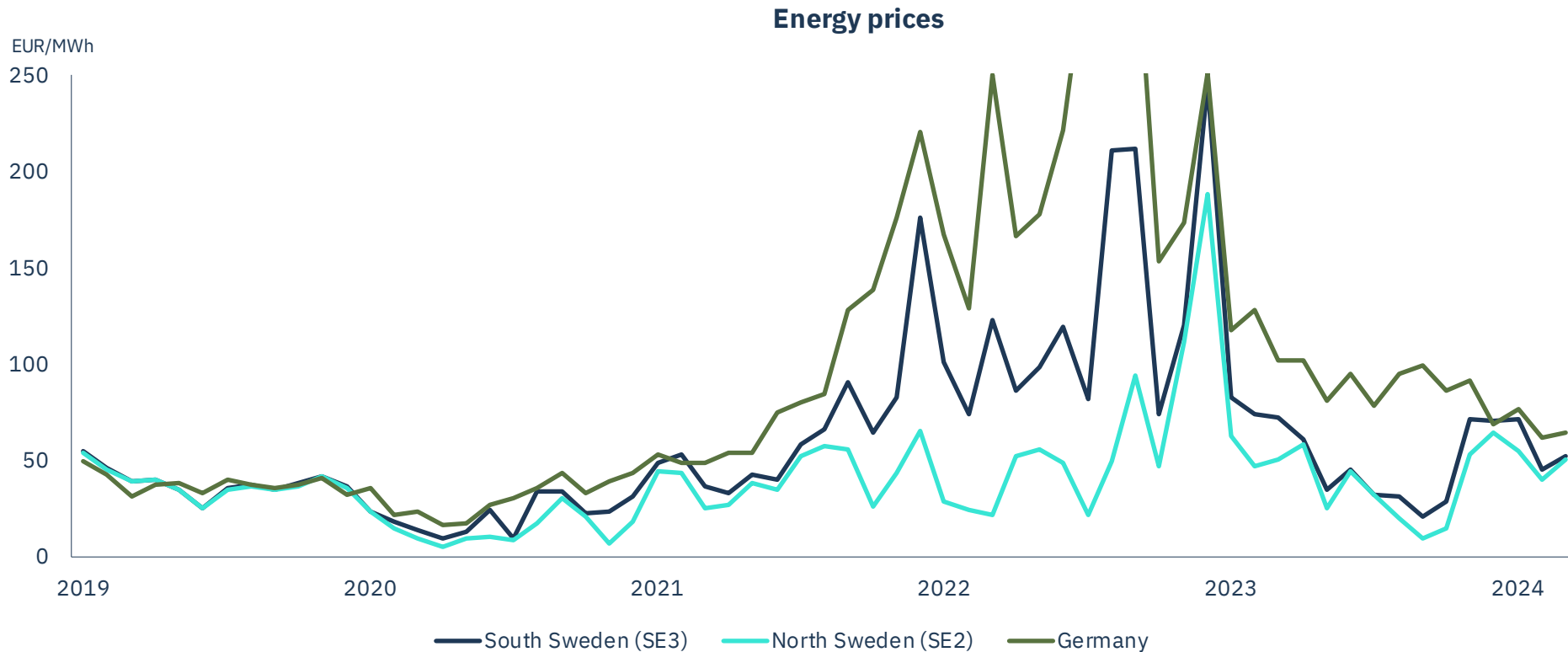

Hydro earnings at strong levels

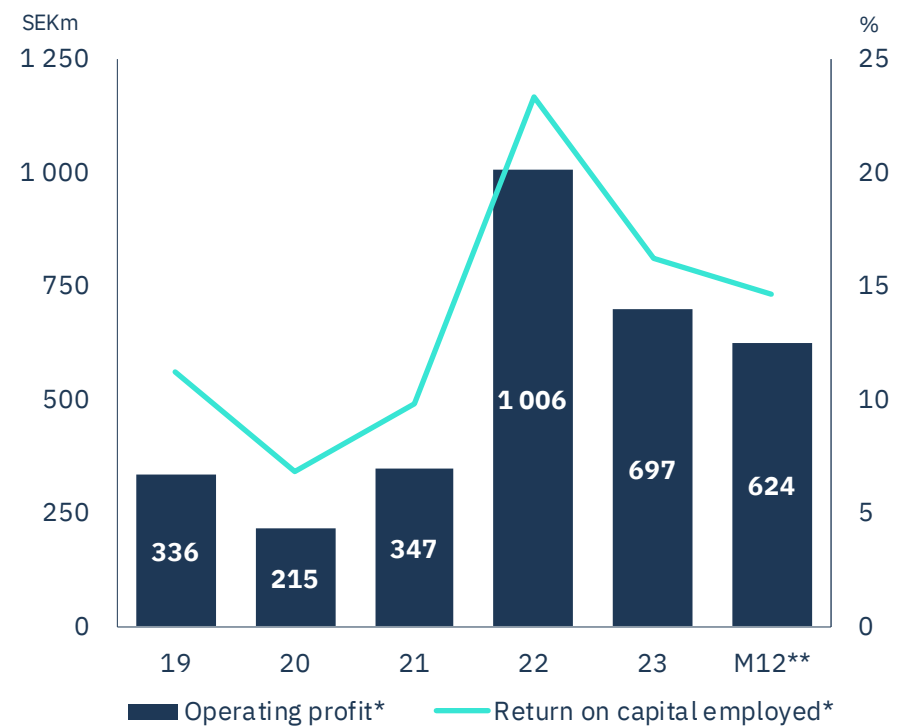
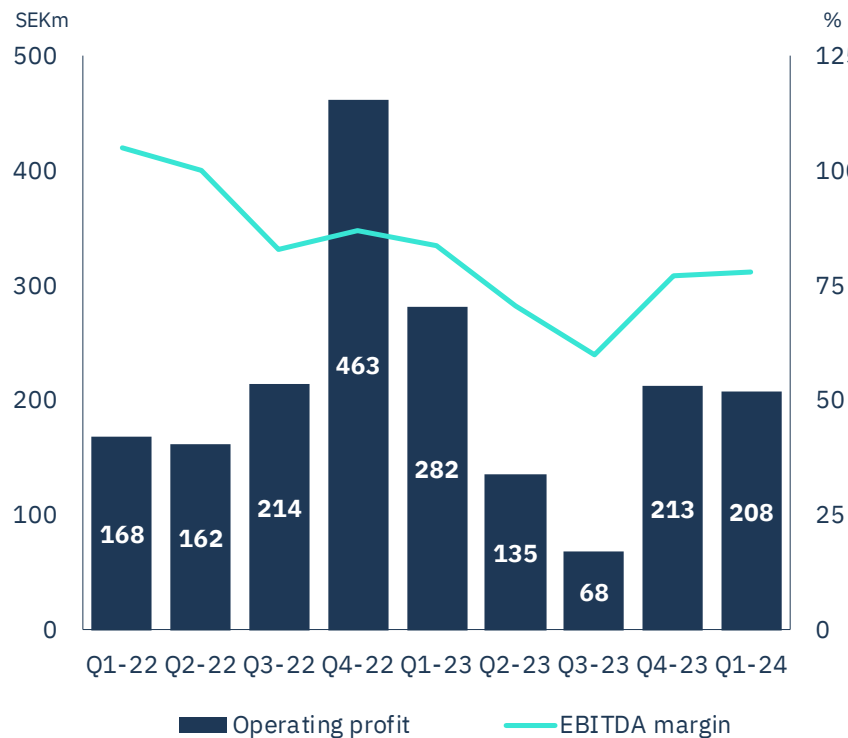

Wood Products

1.5 million m³ per year

Global shortage of logs constrains supply

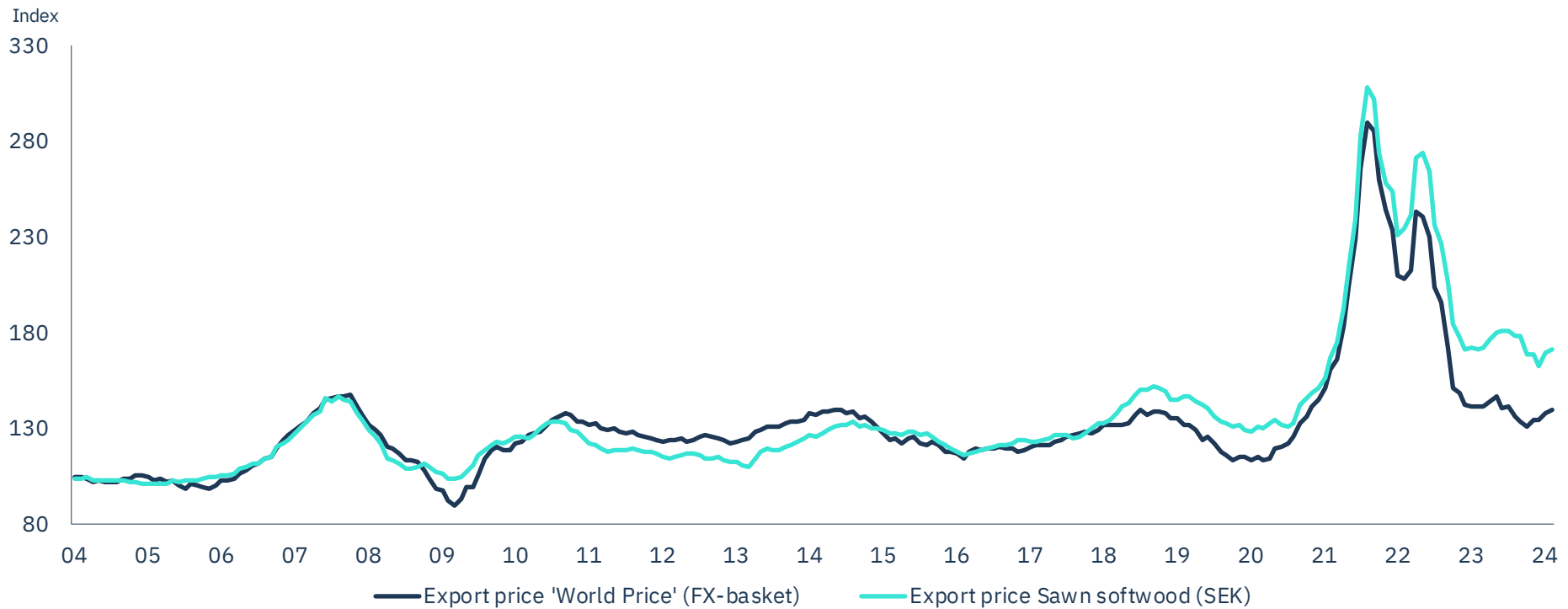

Downtime impacting profitability

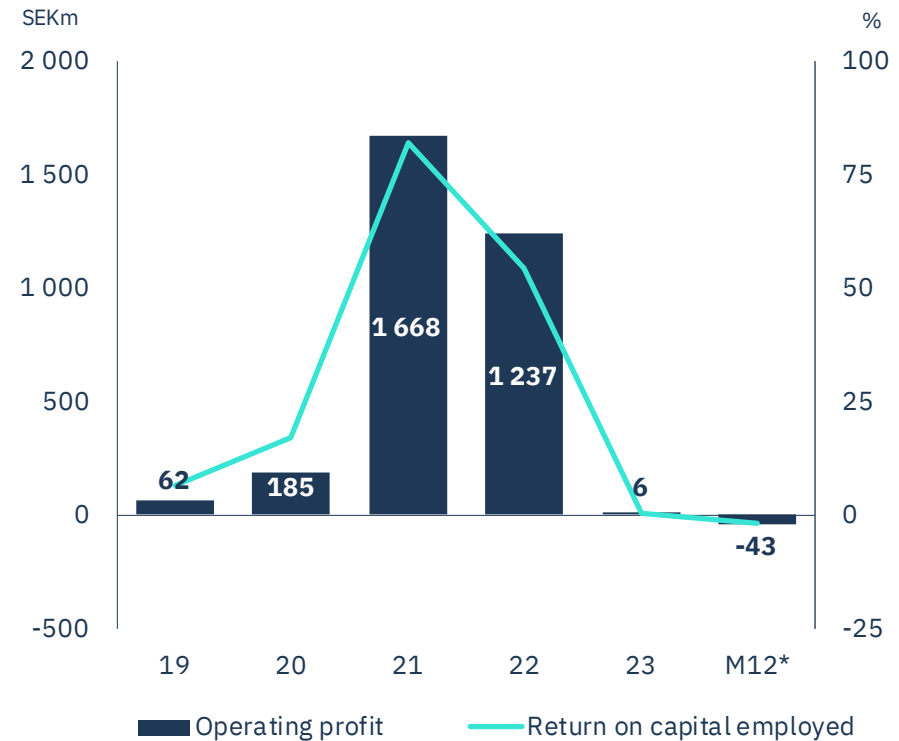
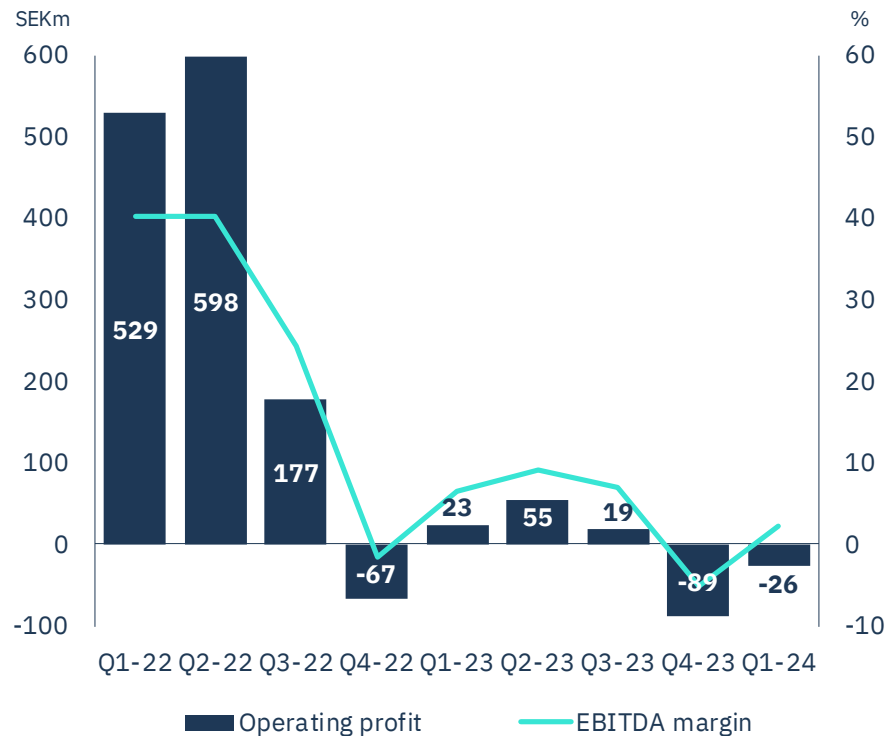

Board and Paper

1.5 million tonnes per year

Board destocking is over

Price pressure fading

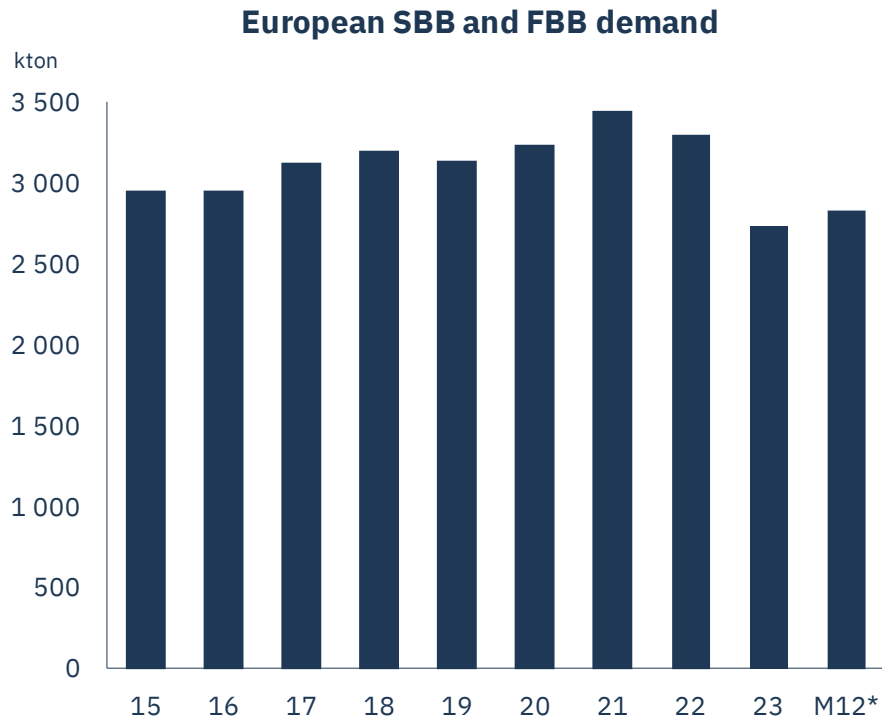

*Q2-23 – Q1-24

**Adjusted for rebates

Source: CEPI and Fastmarkets RISI

Paper prices declining somewhat

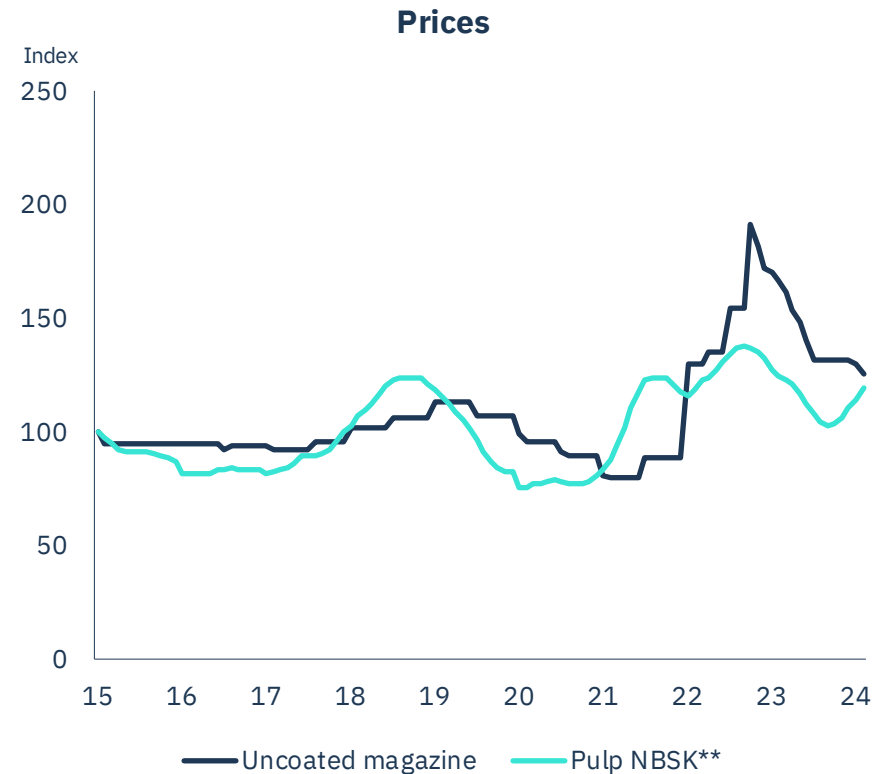
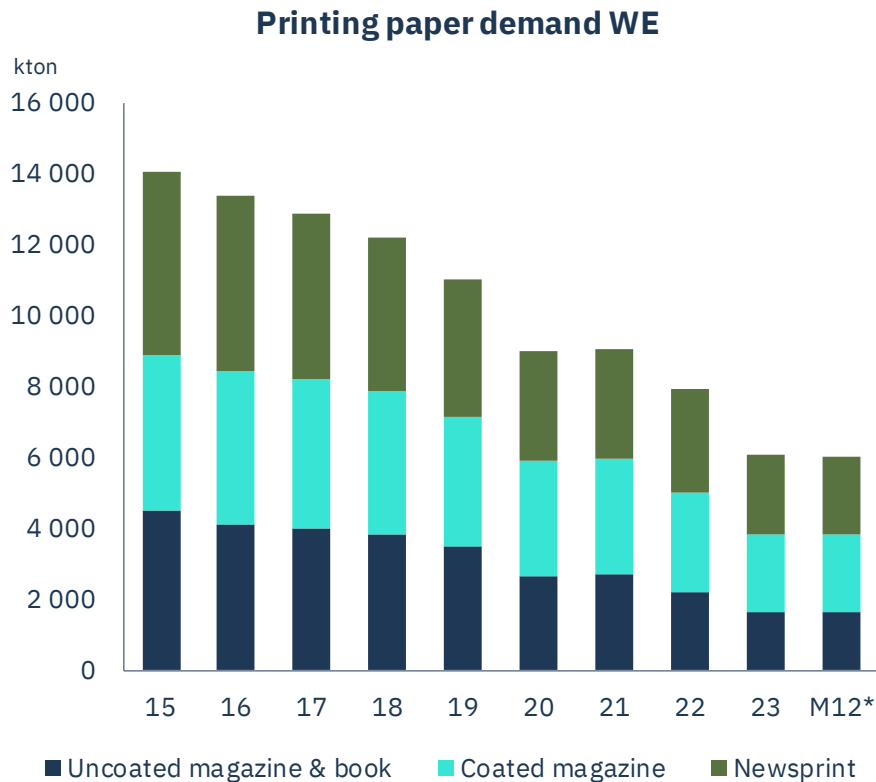

Lower prices and energy costs impacting profit

Some compensation from higher deliveries

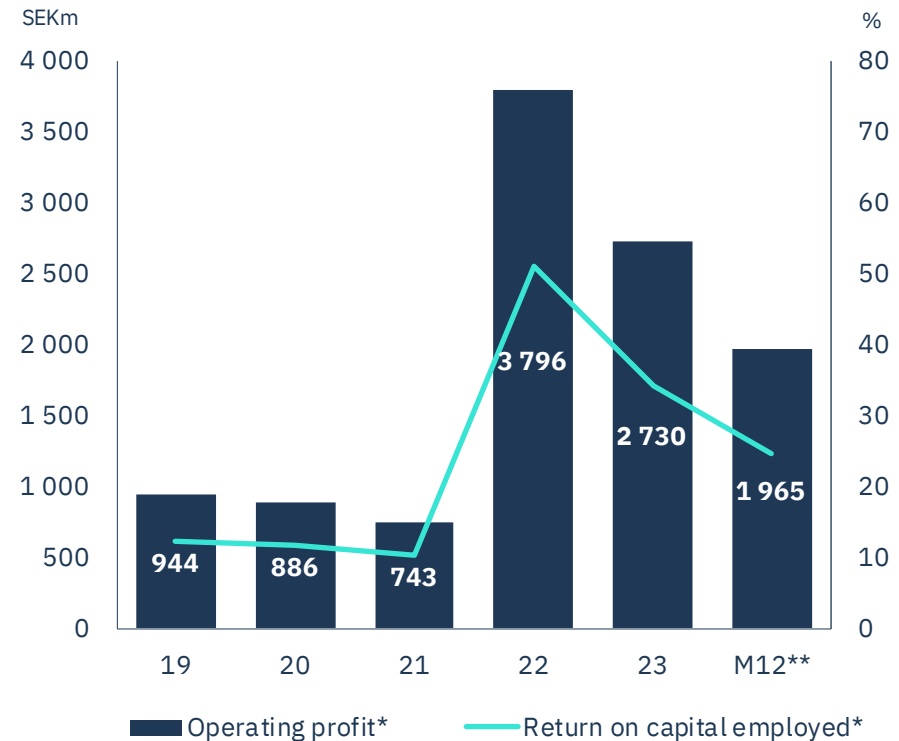
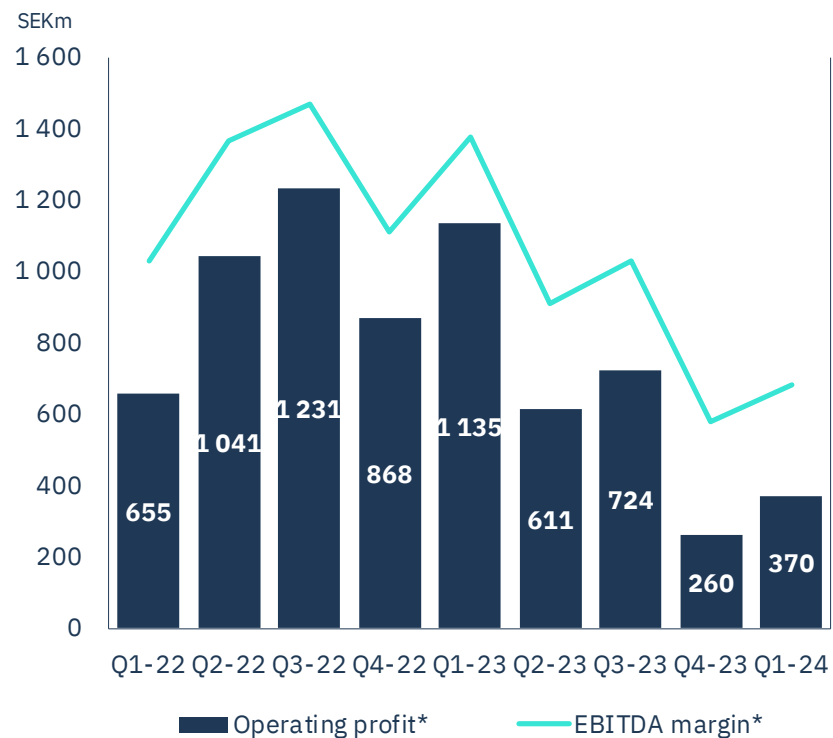

A photograph of a pine forest with a dirt path and a pile of logs. The scene is captured from a low angle, looking down a dirt path that winds through a dense stand of tall, thin pine trees. The ground is covered in green moss and small plants. On the left side of the path, there is a large pile of cut logs. The lighting is bright, suggesting a sunny day, with long shadows cast across the forest floor. A solid teal bar is at the top of the image.

Group

Solid earnings despite slow cycle

Good contribution from forest, hydro power & paper

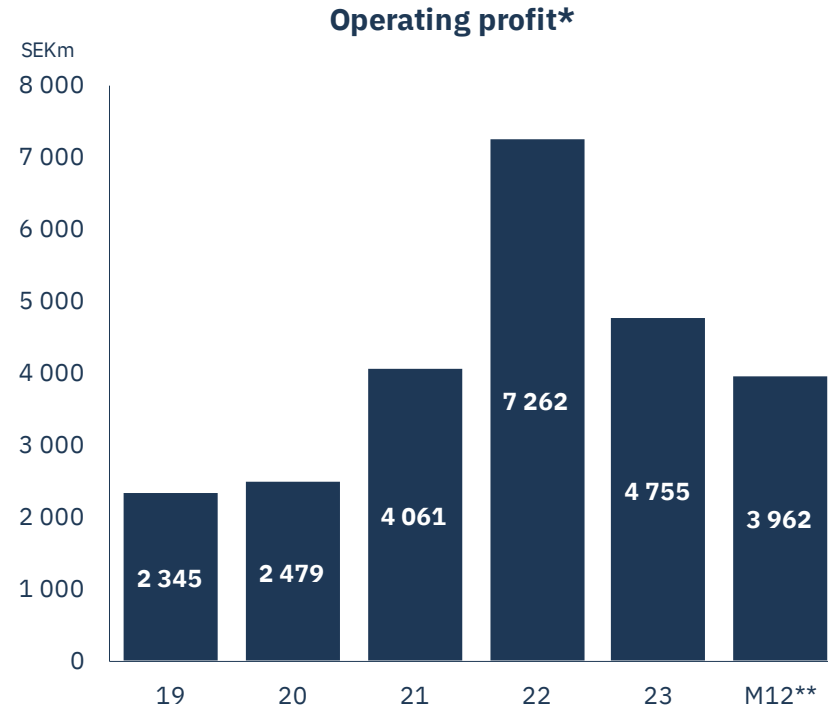
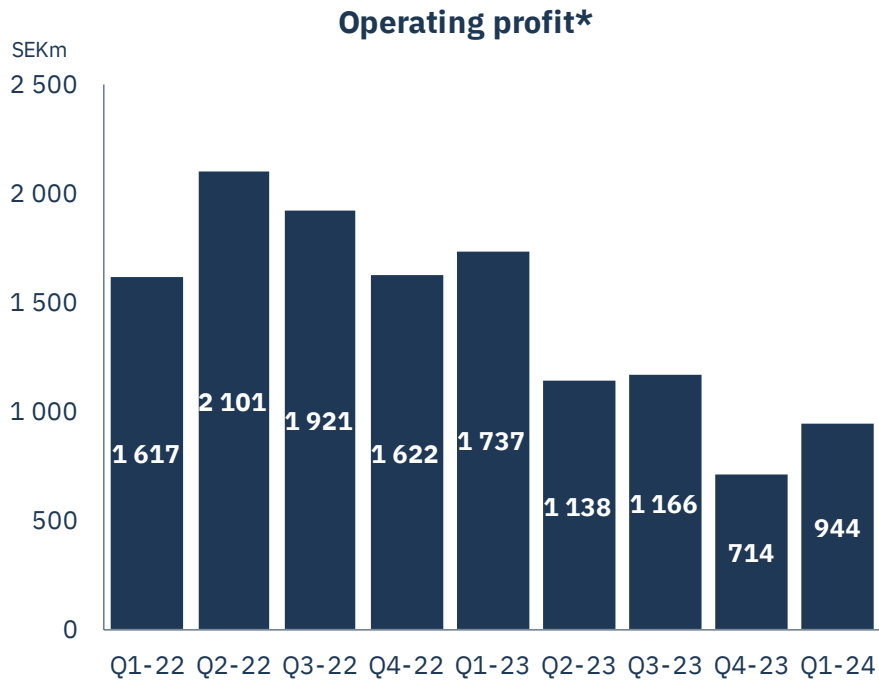

A photograph of a forest with a large tree trunk in the foreground and many smaller trees in the background. The text "Growing a sustainable future" is overlaid in the center.

Growing a sustainable future

EU has high ambitions for climate & ecosystems



European industry has not decarbonised

Biodiversity is under pressure

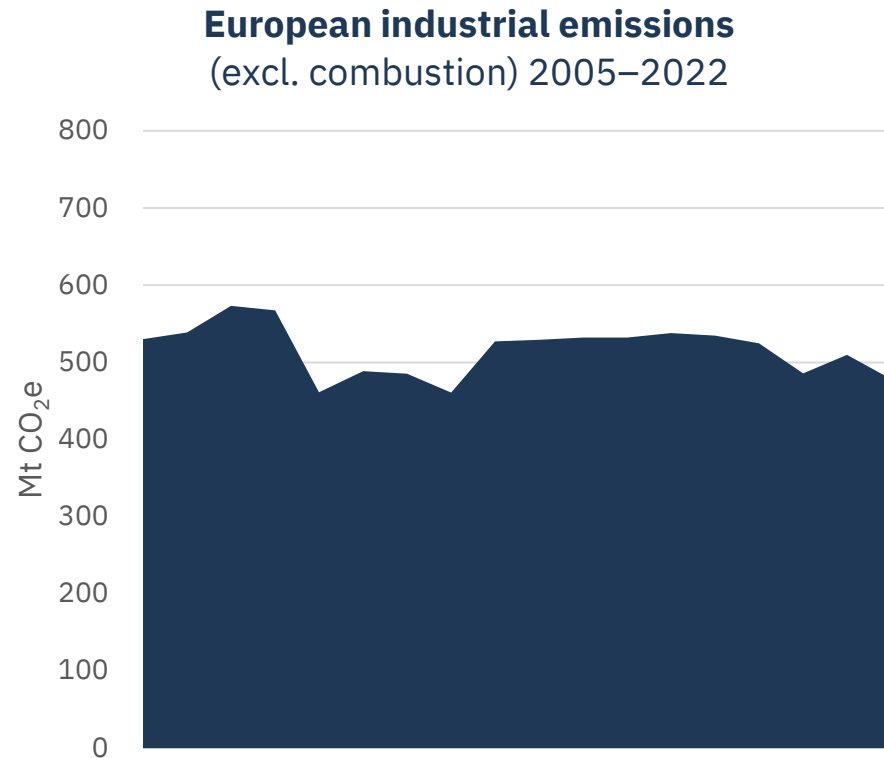

Source: European Environment Agency

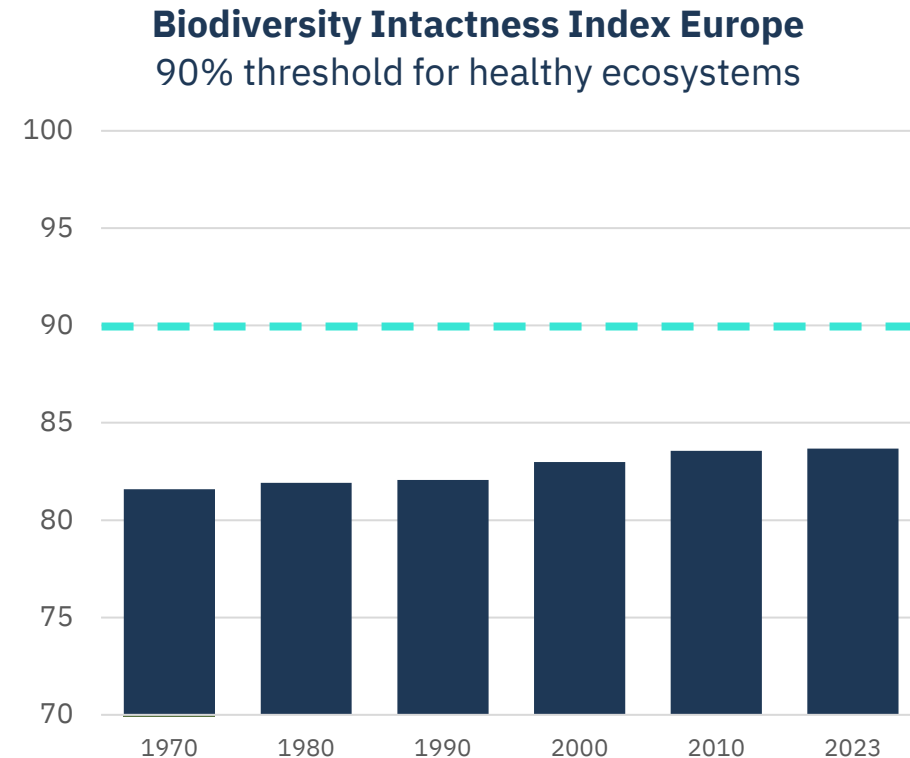

Source: [Natural History Museum](#)

We have lowered our fossil emissions by 90%

Swedish ecosystems are in balance

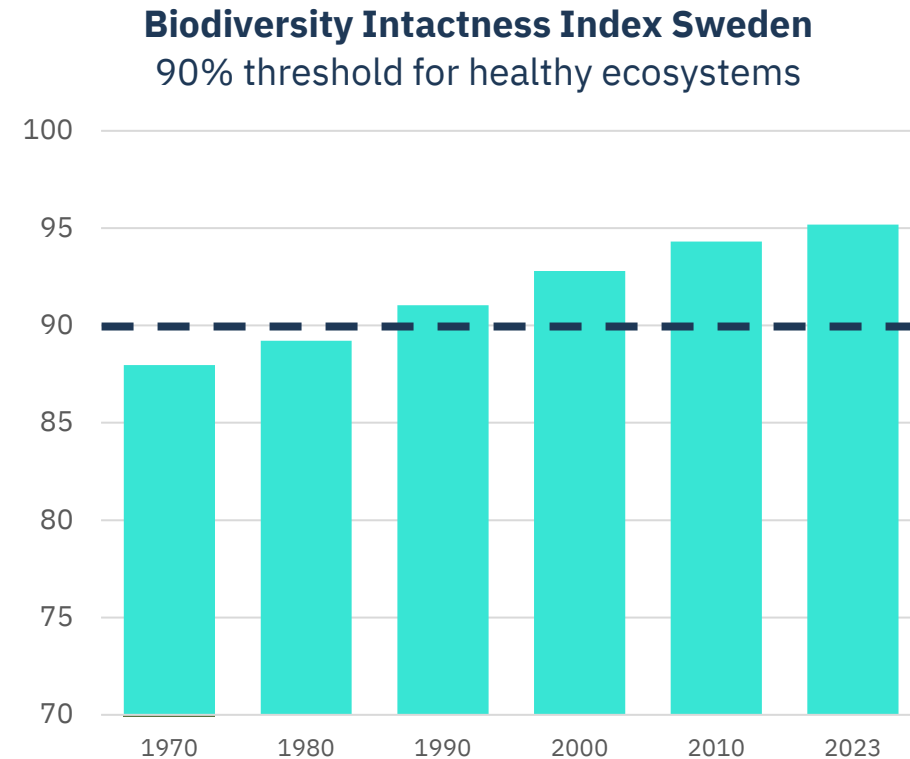
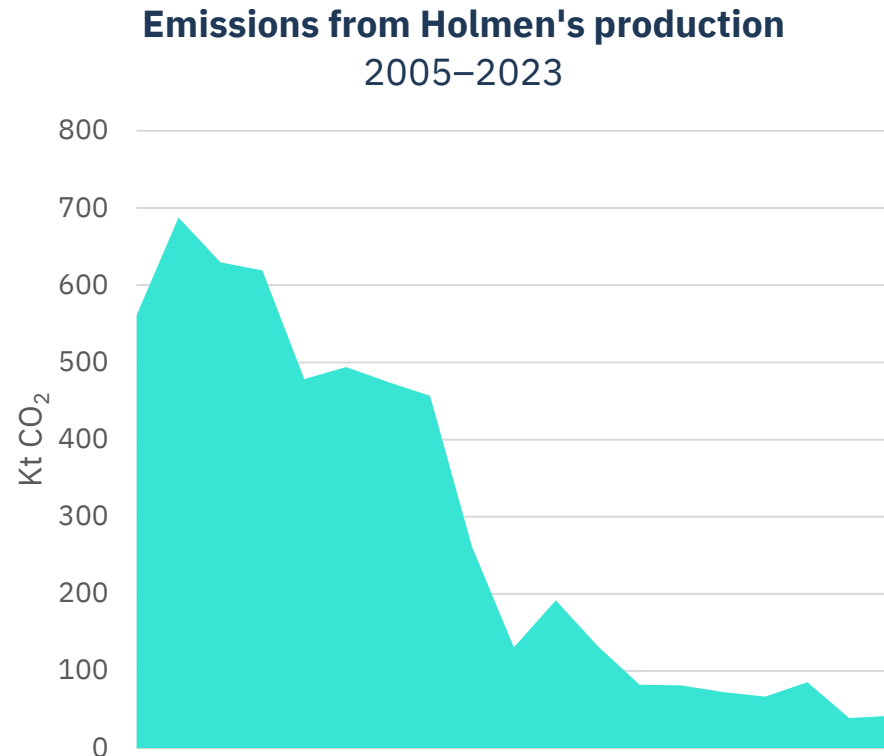

Source: [Natural History Museum](#)

Access to wood & fossil-free energy

Forrest assets*

- >65
- 51-65
- 31-50
- 11-30

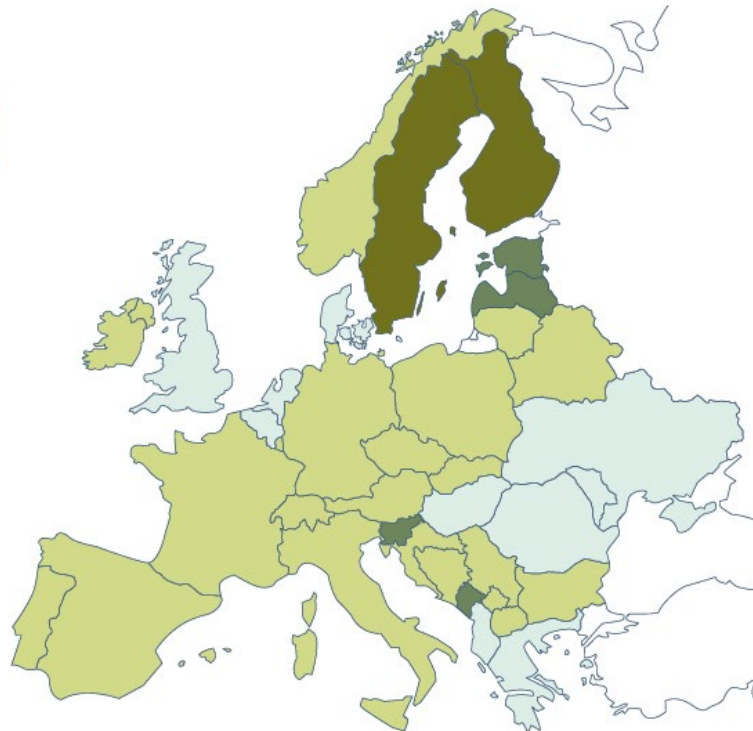

Carbon intensity from electricity production**

- <100
- 101-200
- 201-300
- 301-500
- >500
- No data

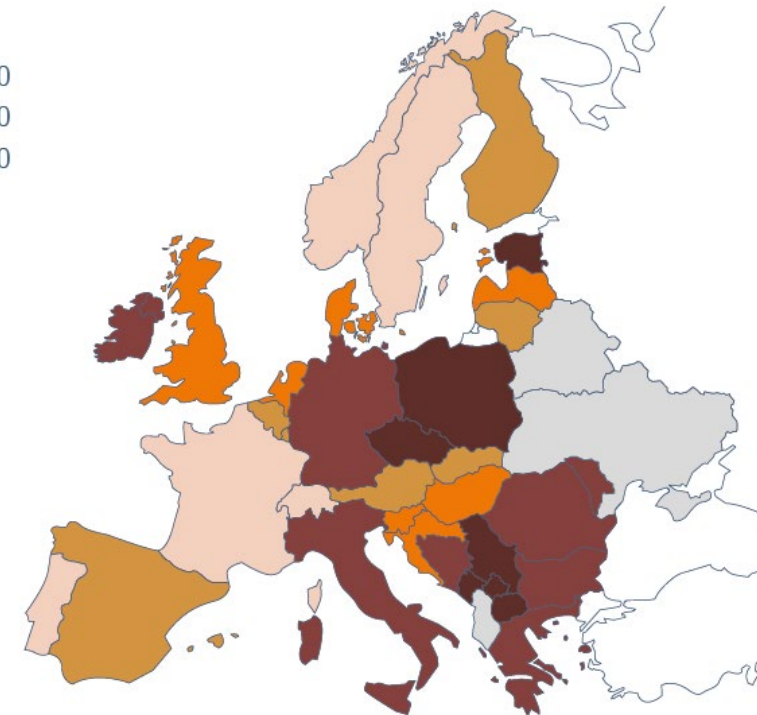

Clean air and plenty of water in the Nordics

Air pollution*

- <8
- 8–9
- 10–11
- 12–14
- >14
- No data

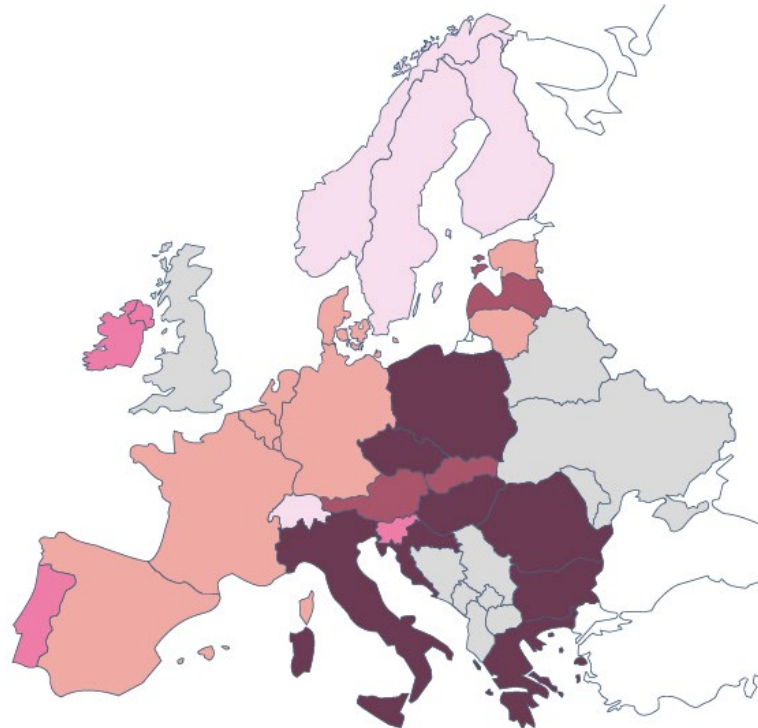

Water stress**

- Low
- Low–medium
- Medium–high
- High
- Extremely high
- No data

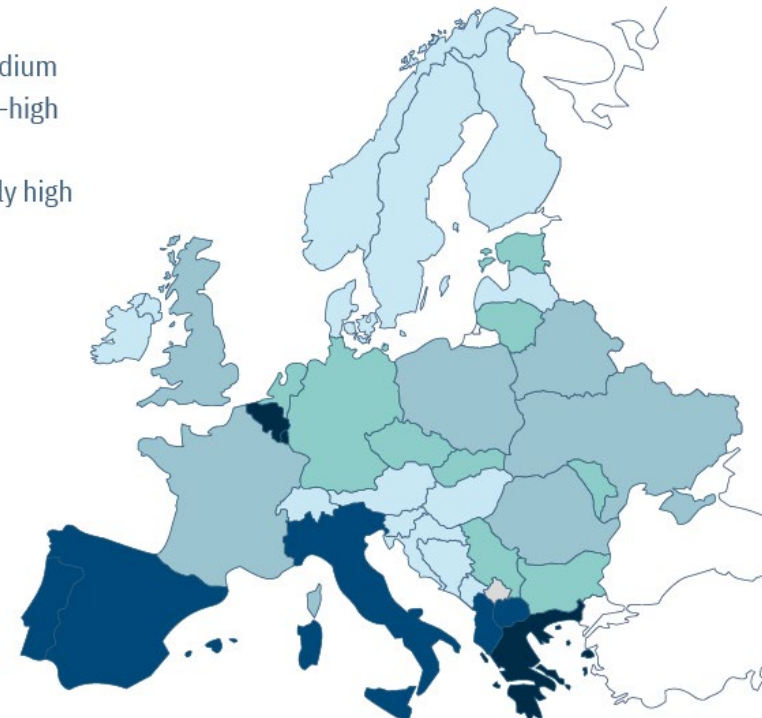

We're beyond net zero

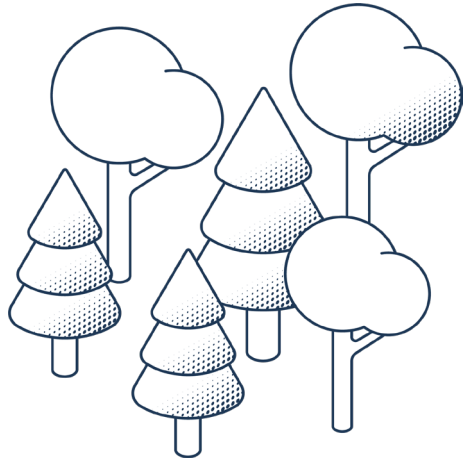

1.6 Mt CO₂
Net increase in growing forest

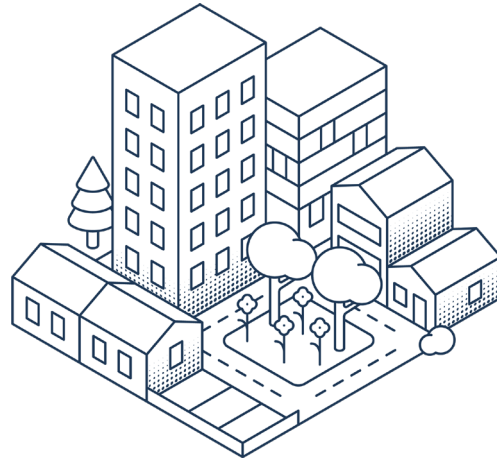

0.5 Mt CO₂
Net storage in buildings

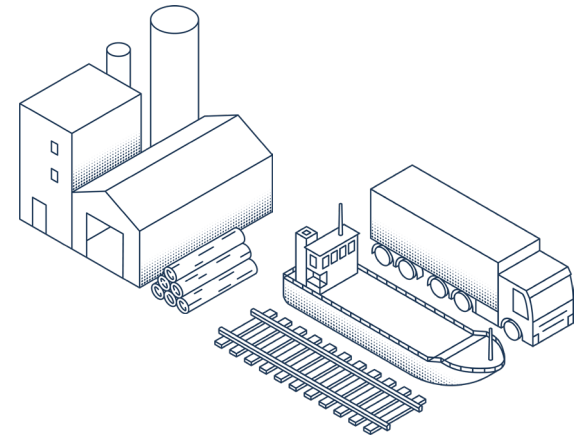

-0.1 Mt CO₂e Scope 1+2
-0.6 Mt CO₂e Scope 3

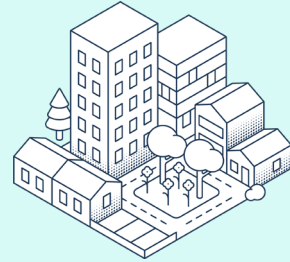

Wood products
1.5 Mm3

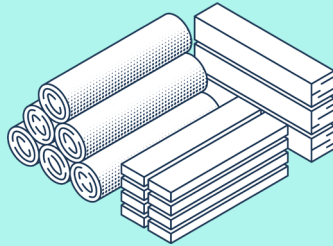

Packaging,
books & magazines
1.5 Mton

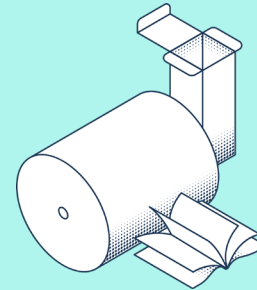

Harvest in own forests
2.8 Mm3

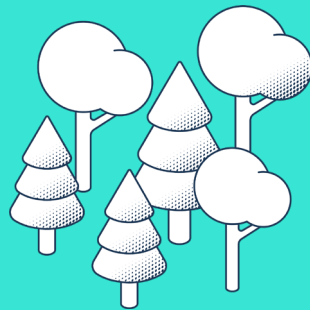

Hydro and wind power
1.8 TWh



1.3 million ha total land area

HOLMEN

holmen.com